



FFUL 1913 P
FFUL 1913 X

GB English

Operating Instructions

REFRIGERATOR/FREEZER COMBINATION

Contents

Operating Instructions, 1
Assistance, 2
Description of the appliance, 3
Description of the appliance, 4
Reversible Doors, 5
Installation, 6
Start-up and use, 6
Maintenance and care, 7
Precautions and tips, 7
Troubleshooting, 8

GB

Assistance

Before calling for Assistance:

- Check if the malfunction can be solved on your own (see Troubleshooting).
- If after all the checks, the appliance still does not operate or the problem persists, call the nearest Service Centre

Communicating:

- type of malfunction
- appliance model (Mod.)
- serial number (S/N)

This information can be found on the data plate located on the bottom left side of the refrigerator compartment.

Never call on unauthorized technicians and always refuse spare parts which are not originals.

GB - model

Mod. RG 2330		TI	Cod. 93139180000		S/N 704211801	
230 - 240 V	Hz	150 W	70% W	Fuse	A	Max 15
Total	340	75			Freez. Capac	Class
Gross Bruto Brut	Gross Bruto Brut	Net Util Utile	Gross Bruto Brut	Poder de Cong	kg/24 h	Clase N
Compr. Syst.	R 134 a	Test Pressure	HIGH-235		4,0	Classe
Kompr.	kg 0,090	P.S-L	LOW 140			
Made in Italy 13918						

GB - serial number

Description of the appliance

Control panel

- 1 FREEZER OPERATION** Button to regulate the temperature the freezer compartment. Button is used with **SUPER FREEZE** Button to switch on/switch off the product by pressing both 3 seconds
- 2 SUPER FREEZE** Button (rapid freezing) to freeze fresh food. Press button for 3 seconds to switch on the product while it is switched off
- 3 SUPER FREEZE** Blue light illuminates when **SUPER FREEZE** button is pressed.
- 4 FREEZER TEMPERATURE** Yellow light The temperature of the Freezer is consisted with 4 levels as indicated on serigraphy
- 5 FRIDGE TEMPERATURE** Yellow light The temperature of the Fridge is consisted with 4 levels as indicated on serigraphy
- 6** When the **SUPER COOL** button is pushed , the blue light of the **SUPER COOL** lights up.
- 7 SUPER COOL** Button (quick cool) to lower the temperature of the refrigerator compartment rapidly.
- 8 REFRIGERATOR OPERATION** button to regulate the temperature of the refrigerator compartment.

!The indicator lights are also used to indicate an unusual temperature increase in the freezer compartment (see Troubleshooting).

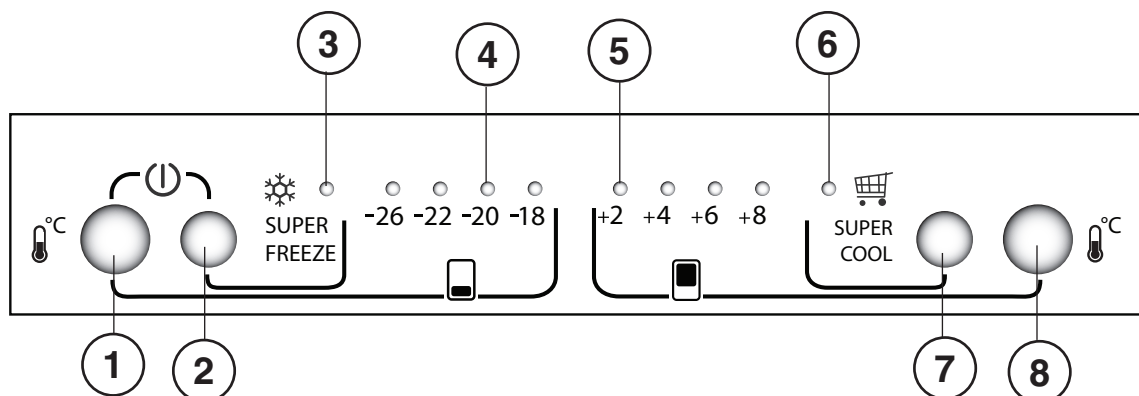

Description of the appliance

Overall view

The instructions contained in this manual are applicable to different model refrigerators. The diagrams may not directly represent the appliance purchased. For more complex features, consult the following pages.

- 1 Levelling **FEET**
- 2 **FREEZER** and **STORAGE** compartment
- 3 **BOTTLE** shelf*
- 4 **Food Care Zone / Food Care Zone 0°C / Safe Defrost***
- 5 **FRUIT** and **VEGETABLE** bin*
- 6 Removable multipurpose **SHELVES***
- 7 **Control panel**.
- 8 **WINE RACK***

* Varies by number and/or position, available only on certain models.

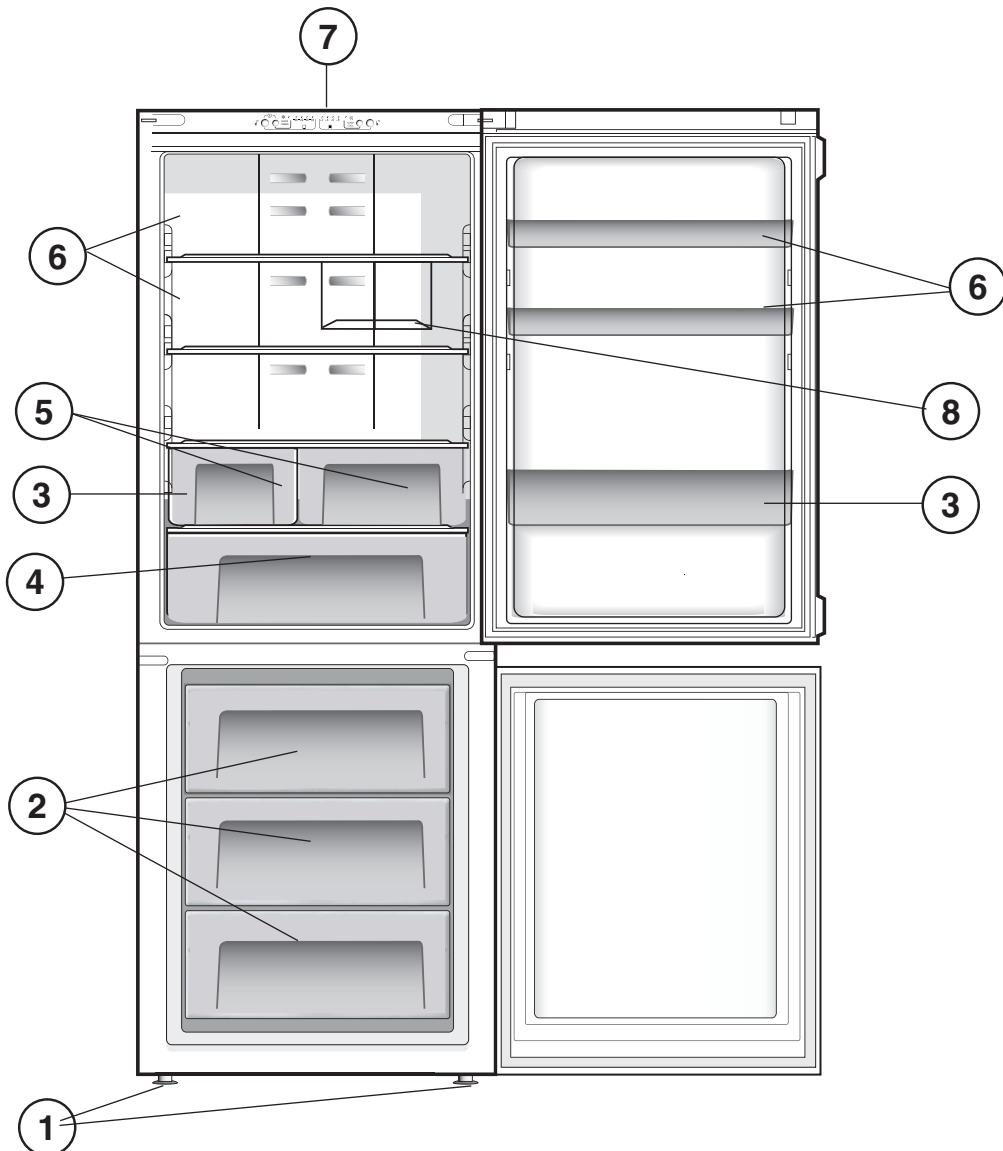

GB

Reversible doors

If it is necessary to change the direction in which the doors open, please contact the Technical Assistance Centre.

Installation

! Before placing your new appliance into operation please read these operating instructions carefully. They contain important information for safe use, for installation and for care of the appliance.

! Please keep these operating instructions for future reference. Pass them on to possible new owners of the appliance.

Positioning and connection

Positioning

1. Place the appliance in a well-ventilated humidity-free room.
2. Do not obstruct the rear fan grills. The compressor and condenser give off heat and require good ventilation to operate correctly and save energy.
3. Leave a space of at least 10 cm between the top part of the appliance and any furniture above it, and at least 5 cm between the sides and any furniture/side walls.
4. Ensure the appliance is away from any sources of heat (direct sunlight, electric stove, etc.).
5. In order to maintain the correct distance between the appliance and the wall behind it, fit the spacers supplied in the installation kit, following the instructions provided.

Levelling

1. Install the appliance on a level and rigid floor.
2. If the floor is not perfectly horizontal, adjust the refrigerator by tightening or loosening the front feet.

Electrical connections

After the appliance has been transported, carefully place it vertically and wait at least 3 hours before connecting it to the electricity mains. Before inserting the plug into the electrical socket ensure the following:

- The appliance is earthed and the plug is compliant with the law.
- The socket can withstand the maximum power of the appliance, which is indicated on the data plate located on the bottom left side of the fridge (e.g. 150 W).
- The voltage must be in the range between the values indicated on the data plate located on the bottom left side (e.g. 220-240V).
- The socket is compatible with the plug of the appliance. If the socket is incompatible with the plug, ask an authorised technician to replace it (see Assistance). Do not use extension cords or multiple sockets.

! Once the appliance has been installed, the power supply cable and the electrical socket must be easily accessible.

! The cable must not be bent or compressed.

! The cable must be checked regularly and replaced by authorised technicians only (see Assistance).

! The manufacturer declines any liability should these safety measures not be observed.

Start-up and use

Starting the appliance

! Before starting the appliance, follow the installation instructions (see Installation).

! Before connecting the appliance, clean the compartments and accessories well with lukewarm water and bicarbonate.

! The appliance comes with a motor protection control system which makes the compressor start approximately 8 minutes after being switched on. The compressor also starts each time the power supply is cut off whether voluntarily or involuntarily (blackout).

1. Insert the plug into the socket and switch on the product using the appropriate button, ensure that yellow refrigerator and freezer temperature lights illuminate

2. After a few hours you will be able to put food in the refrigerator.
3. Press the SUPER FREEZE button (rapid freezing): the SUPER FREEZE indicator light will illuminate. Once the refrigerator has reached the optimal temperature, the indicator light goes out and you can begin food storage.

Using the refrigerator to its full potential

- Use the REFRIGERATOR OPERATION button to adjust the temperature (see Description).
- Press the SUPER COOL button (rapid cooling) to lower the temperature quickly. For example, when you place a large number of new food items inside a fridge the internal temperature will rise slightly. The function quickly cools the groceries by temporarily reducing the temperature until it reaches the ideal level.
- Place only cold or lukewarm foods in the compartment, not hot foods (see Precautions and tips).
- Remember that cooked foods do not last longer than raw foods.
- Do not store liquids in open containers. They will increase humidity in the refrigerator and cause condensation to form.

SHELVES: Due to the special guides the shelves are removable and the height is adjustable, allowing easy storage of large containers and food.

FRUIT and VEGETABLE bin*

The salad crispers fitted inside the fridge have been specially designed for the purpose of keeping fruit and vegetables fresh and crisp. Open the humidity regulator (position **B**) if you want to store food in a less humid environment like fruit, or close it (position **A**) to store food in a more humid environment like vegetable

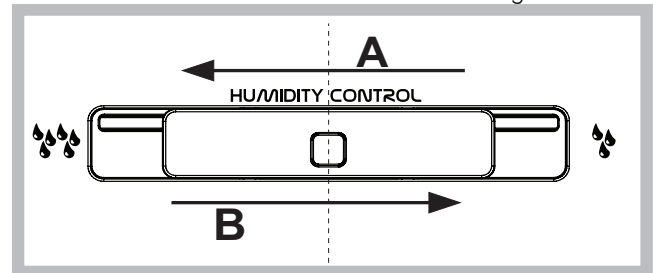

Using the freezer to its full potential

- Use the FREEZER OPERATION button to adjust the temperature (see Description).
- Do not re-freeze food that is defrosting or that has already been defrosted. These foods must be cooked and eaten (within 24 hours).
- Fresh food that needs to be frozen must not come into contact with food that has already been defrosted.
- Do not place glass bottles which contain liquids, and which are corked or hermetically sealed in the freezer because they could break.
- The maximum quantity of food that may be frozen daily is indicated on the plate containing the technical properties located on the bottom left side of the refrigerator compartment (for example: Kg/24h: 4).
- To freeze (if the freezer is already operating): press the rapid freezing SUPER FREEZE button (corresponding blue indicator light illuminates), insert the food and close the door. The function is disabled automatically after 24 hours or when optimal temperatures have been reached (indicator light goes out)

! Do not store food too large in the upper freezer drawer if it presents the 'Ice Device'.

! Do not open the door during freezing.

! If there is a power cut or malfunction, do not open the freezer door. This will help maintain the temperature inside the freezer, ensuring that foods are conserved for at least 9 -14 hours.

Easy Ice *

The double tub was designed to optimise space in the freezer compartment and to ensure that ice is always readily available. The trays can be stacked or filled and used separately. Furthermore, the special fastening system makes Easy Ice an extremely flexible solution, as it can be positioned in the right or left part of the top drawers.

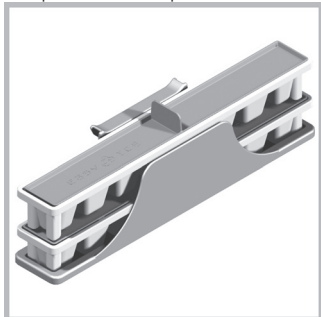
**Food Care Zone ***

Area dedicated to the storage of fresh food, such as meat and fish. Thanks to the low temperature inside the compartment, the Food Care Zone extends the period of time for which the food can be stored, keeping it fresh for up to a week.

Food Care Zone 0°C / Safe Defrost* :

A compartment designed to keep delicate food such as meat and fish fresh. The low temperature in the compartment (-2 / +3° C) makes it possible to store the food for up to one week - tests performed on meat products - without changing its nutrients, appearance and flavour.

The compartment is also very suitable for healthy food defrosting, as low-temperature defrosting prevents any proliferation of microorganisms, while protecting its taste and organoleptic properties.

It is not suitable for fruit, vegetables and green salad. But it can be used for fresh or very fresh dairy products and milk, stuffed fresh pasta and even cooked food or leftovers.

Maintenance and care

Switching the appliance off

During cleaning and maintenance it is necessary to disconnect the appliance from the electricity supply:

1. press the FREEZER OPERATION Button and SUPER FREEZE Button for 3 seconds to switch off the product
2. pull the plug out of the socket

! If this procedure is not followed, the alarm may sound. This alarm does not indicate a malfunction. To restore normal operation insert the plug into the socket, press the FREEZER OPERATION and SUPER FREEZE button and set the FREEZER OPERATION button on the desired value. To disconnect the appliance, follow point 1 and 2.

Cleaning the appliance

- The external and internal parts, as well as the rubber seals may be cleaned using a sponge that has been soaked in lukewarm water and bicarbonate of soda or neutral soap. Do not use solvents, abrasive products, bleach or ammonia.
- The removable accessories may be soaked in warm water and soap or dishwashing liquid. Rinse and dry them carefully.
- The back of the appliance may collect dust which can be removed by delicately using the hose of a vacuum cleaner set on medium power. The appliance must be switched off and the plug must be pulled out before cleaning the appliance.
- During the cleaning of the slide rails for the drawers in the freezer compartment, it may happen that the automatic drawer

closure mechanism is deactivated. To reactivate it, simply close the drawer a little more forcefully than is usually necessary.

Avoiding mould and unpleasant odours

- The appliance is manufactured with hygienic materials which are odour free. In order to maintain an odour free refrigerator and to prevent the formation of stains, food must always be covered or sealed properly.
- If you want to switch the appliance off for an extended period of time, clean the inside and leave the doors open.

I Care function

The I Care function can be enabled to optimise energy consumption. Press and hold down the SUPER COOL and REFRIGERATOR OPERATION buttons simultaneously for at least 6 seconds to enable this function.

On enabling the function, 4 indicator lights will go on for 2 seconds: SUPER COOL light, SUPER FREEZE light and two temperature lights - one for the refrigerator and one for the freezer.

After 5 seconds the interface will enter the energy saving mode and the indicator lights will go off. The interface stays off even when the door is opened. Just press any button to switch it on again. Press the adjustment buttons to change the temperature. Consumption will be optimised 48h after the function was enabled. To disable the I Care function, switch off the product (see description). The product can be switched on again for normal operation.

In humid environments, when the I Care function is enabled, slight condensation may form on the doors; normal operating conditions are restored when the function is disabled.

Replacing the led*

Thanks to the powerful light it emits, the new LED lighting system offers a clear view of all foods, with no shadowy areas. If the LED needs to be replaced, please contact the Technical Assistance Service.

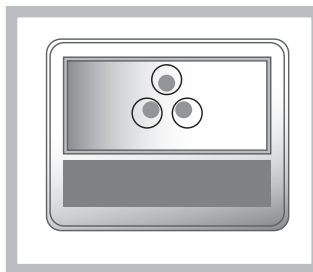
**Replacing the light bulb ***

To replace the light bulb in the refrigerator compartment, pull out the plug from the electrical socket. Follow the instructions below. Access the light bulb by removing the cover as indicated in the diagram. Replace it with a similar light bulb within the power range indicated on the cover.

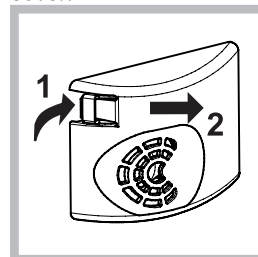

Precautions and tips

! The appliance was designed and manufactured in compliance

* Varies by number and/or position, available only on certain models.

with international safety standards. The following warnings are provided for safety reasons and must be read carefully.



This appliance complies with the following Community Directives:
 - 73/23/EEC of 19/02/73 (Low Voltage) and subsequent amendments;
 -89/336/EEC of 03.05.89 (Electromagnetic Compatibility) and subsequent amendments;
 - 2002/96/CE..

General safety

- The appliance was designed for domestic use inside the home and is not intended for commercial or industrial use.
- The appliance must be used to store and freeze food products by adults only and according to the instructions in this manual.
- The appliance must not be installed outdoors, even in covered areas. It is extremely dangerous to leave the appliance exposed to rain and storms.
- Do not touch the appliance with bare feet or with wet or moist hands and feet.
- Do not touch the internal cooling elements: this could cause skin abrasions or frost/freezer burns.
- When unplugging the appliance always pull the plug from the mains socket, do not pull on the cable.
- Is not sufficient to switch-off of the product to eliminate all the electrical connections.
- In the case of a malfunction, under no circumstances should you attempt to repair the appliance yourself. Repairs carried out by inexperienced persons may cause injury or further malfunctioning of the appliance.
- Do not use any sharp or pointed utensils or electrical equipment - other than the type recommended by the manufacturer - inside the frozen food storage compartments.
- Do not put ice cubes taken directly from the freezer into your mouth.
- This appliance is not intended for use by persons (including children) with reduced physical, sensory or lack of experience and knowledge unless they have been given supervision or instruction concerning use of the appliance by a person responsible for their safety. Children should be supervised to ensure that they do not play with the appliance.
- Keep packaging material out of the reach of children! It can become a choking or suffocation hazard.

Disposal

- Observe local environmental standards when disposing packaging material for recycling purposes.
- The European Directive 2002/96/EC on Waste Electrical and Electronic Equipment (WEEE), requires that old household electrical appliances must not be disposed of in the normal unsorted municipal waste stream. Old appliances must be collected separately in order to optimise the recovery and recycling of the materials they contain and reduce the impact on human health and the environment. The crossed out "wheeled bin" symbol on the product reminds you of your obligation, that when you dispose of the appliance it must be separately collected. Consumers should contact their local authority or retailer for information concerning the correct disposal of their old appliance.

Respecting and conserving the environment

- Install the appliance in a fresh and well-ventilated room. Ensure that it is protected from direct sunlight and do not place it near heat sources.
- Try to avoid keeping the door open for long periods or opening the door too frequently in order to conserve energy.
- Do not fill the appliance with too much food: cold air must circulate freely for food to be preserved properly. If circulation is impeded, the compressor will work continuously.

- Do not place hot food directly into the refrigerator. The internal temperature will increase and force the compressor to work harder and will consume more energy.

Troubleshooting

If the appliance does not work, before calling for Assistance (see Assistance), check for a solution from the following list.

Any indicator lights do not illuminate.

- If the function I Care is not active (see section), the plug has not been inserted into the electrical socket, or not far enough to make contact, or there is no power in the house.

The motor does not start.

- The appliance comes with a motor protection control (see Start-up and use).

The indicator lights are on but the light is dim.

- Pull out and reverse the plug before putting it back in the socket.

a) The alarm sounds.

- The refrigerator door has remained open for more than two minutes (the buzzer will stop sounding when you shut the door) or the correct switching-off procedure was not followed (see Maintenance).

b) The alarm sounds and the two blue indicator lights flash.

- The temperature in the freezer is too high. Check the quality of the food products and dispose if necessary.



+ buzzer = Heating is excessive

c) The alarm sounds and the two blue indicator and green one lights flash.

- The temperature in the freezer has reached a dangerous level. The food must be disposed immediately.

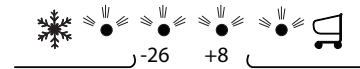

+ buzzer = Heating danger

b/c) In both these cases the freezer will maintain a temperature of about 0°C so that the food does not re-freeze.

To turn off the acoustic signal open and close the refrigerator door. **restore normal operation product should be switched off and switched on by buttons from control panel (See the description)**

The refrigerator and the freezer do not cool well.

- The doors do not close properly or the seals are damaged.
- The doors are opened too frequently.
- The refrigerator or the freezer have been over-filled.

The food inside the refrigerator is beginning to freeze.

- The temperature is not adjusted properly (see description)
- The food is near the back inside wall of the refrigerator.

The motor runs continuously.

- The SUPER FREEZE button has been pressed (rapid freezing): the blue SUPER FREEZE light is on (see Description).
- The door is not closed properly or is continuously opened.
- The outside ambient temperature is very high.

The appliance makes a lot of noise.

- The appliance has not been installed on a level surface (see Installation).
- The appliance has been installed between cabinets that vibrate and make noise.
- The internal refrigerant makes a slight noise even when the compressor is off. This is not a defect, it is normal.